

CRD
RUG
SIZING
GUIDE

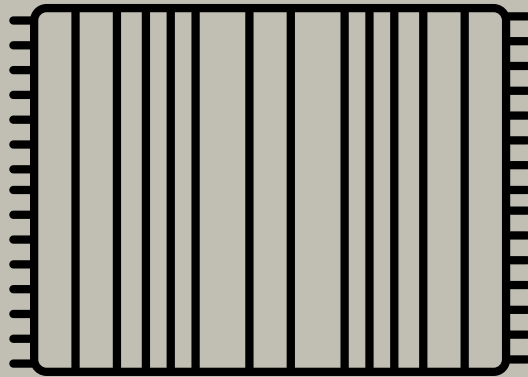

www.carolinerachdesigns.com

CRD

RUG SIZING GUIDE

What size to buy and how to style for your

- Bedroom
- Living Room
- Dining Room



RUG + TABLE SIZING



DINING ROOM

- Keep all chair legs on rug even when pulled out
- 8-16" of space behind chairs
- Keep rug at least 12" away from walls

COMMON RUG SIZES:

6x9
8x10
9x12
10x14

RECTANGLE TABLE Suggested Rug Shapes



CRD

RUG + TABLE SIZING

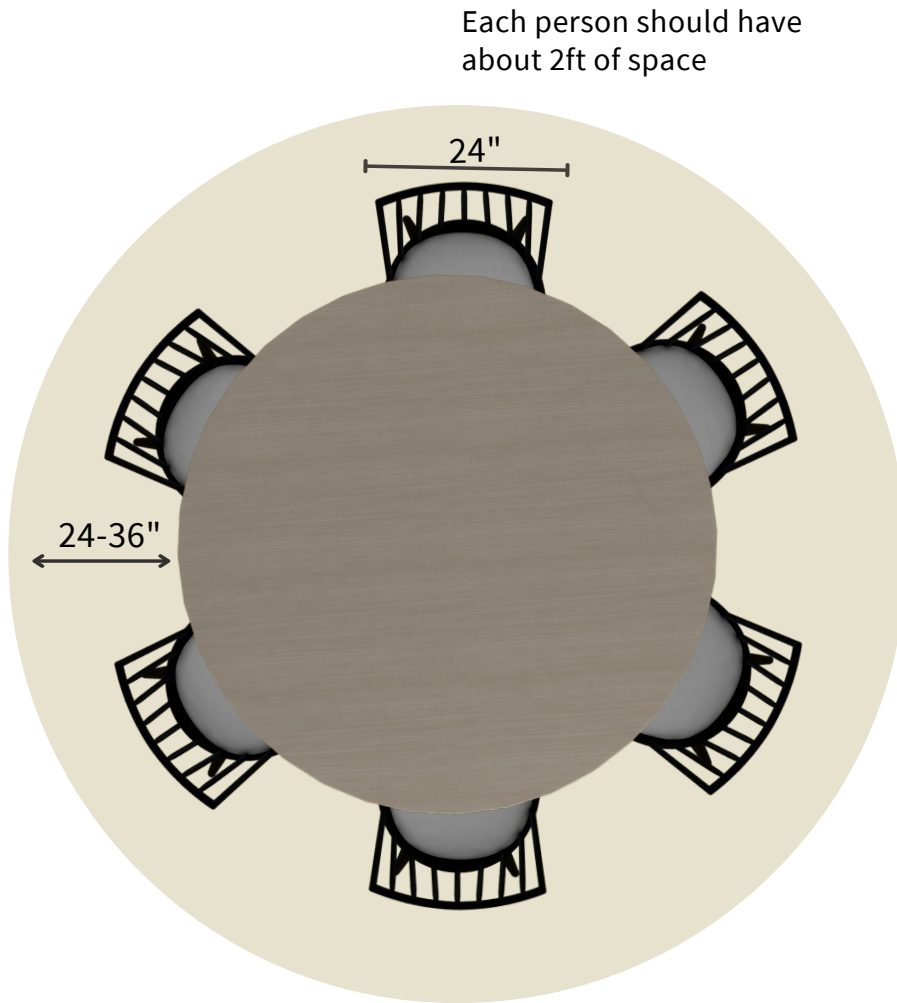

DINING ROOM

- Keep all chair legs on rug even when pulled out
- 8-16" of space behind chairs
- Keep rug at least 12" away from walls

COMMON RUG SIZES:

6 x 9
8 x 10
9 x 12
10 x 14

ROUND TABLE Suggested Rug Shapes

Square

Round

CRD

RUG SIZING: SMALL LIVING SPACE

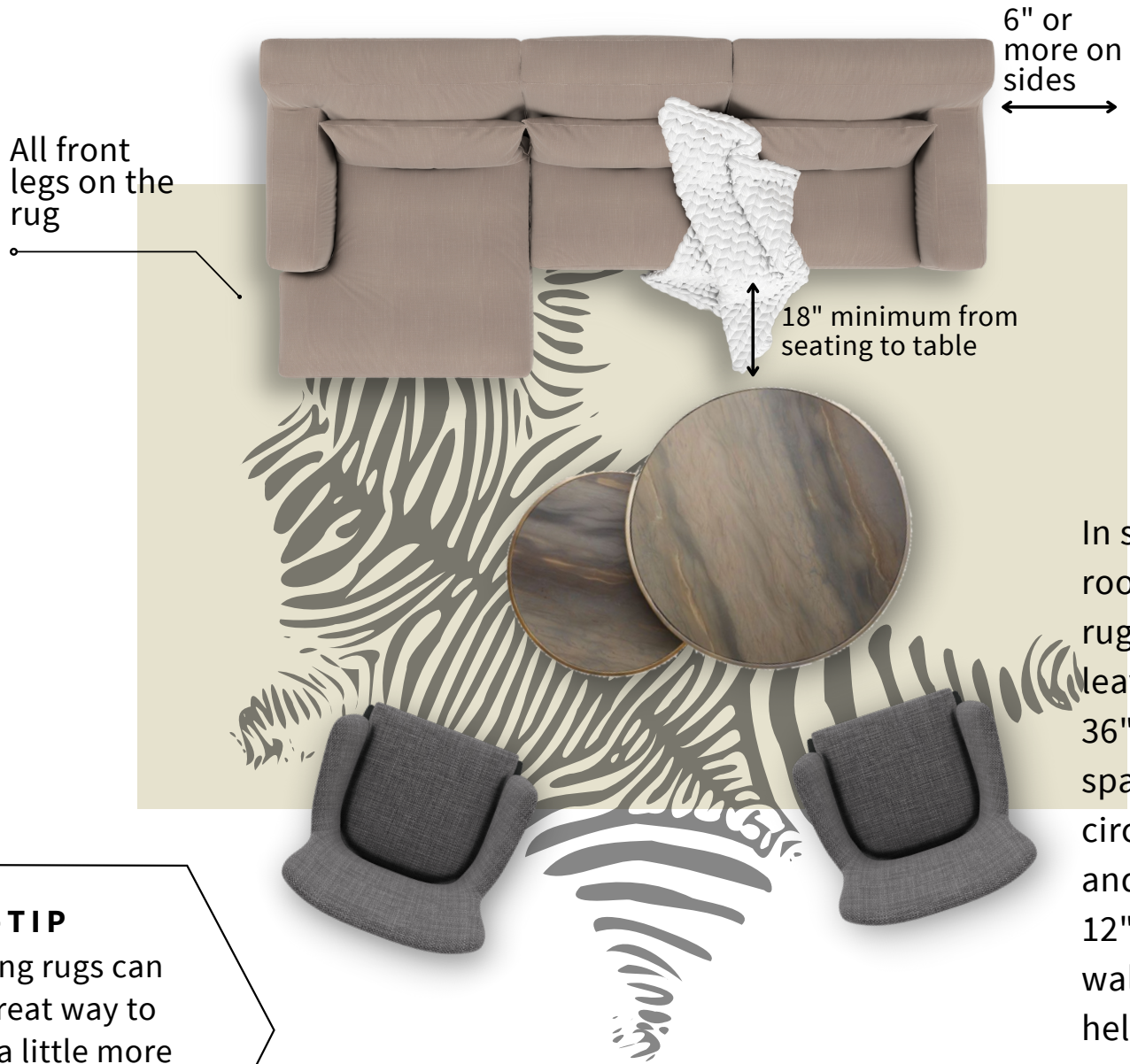

In smaller rooms, use a rug that leaves about 36" of floor space for circulation and at least 12" from any wall. This helps the room look bigger and not like you're forcing it.

PRO-TIP
Layering rugs can be a great way to cover a little more area without buying a bigger rug

CRD

RUG SIZING: LARGE LIVING SPACE

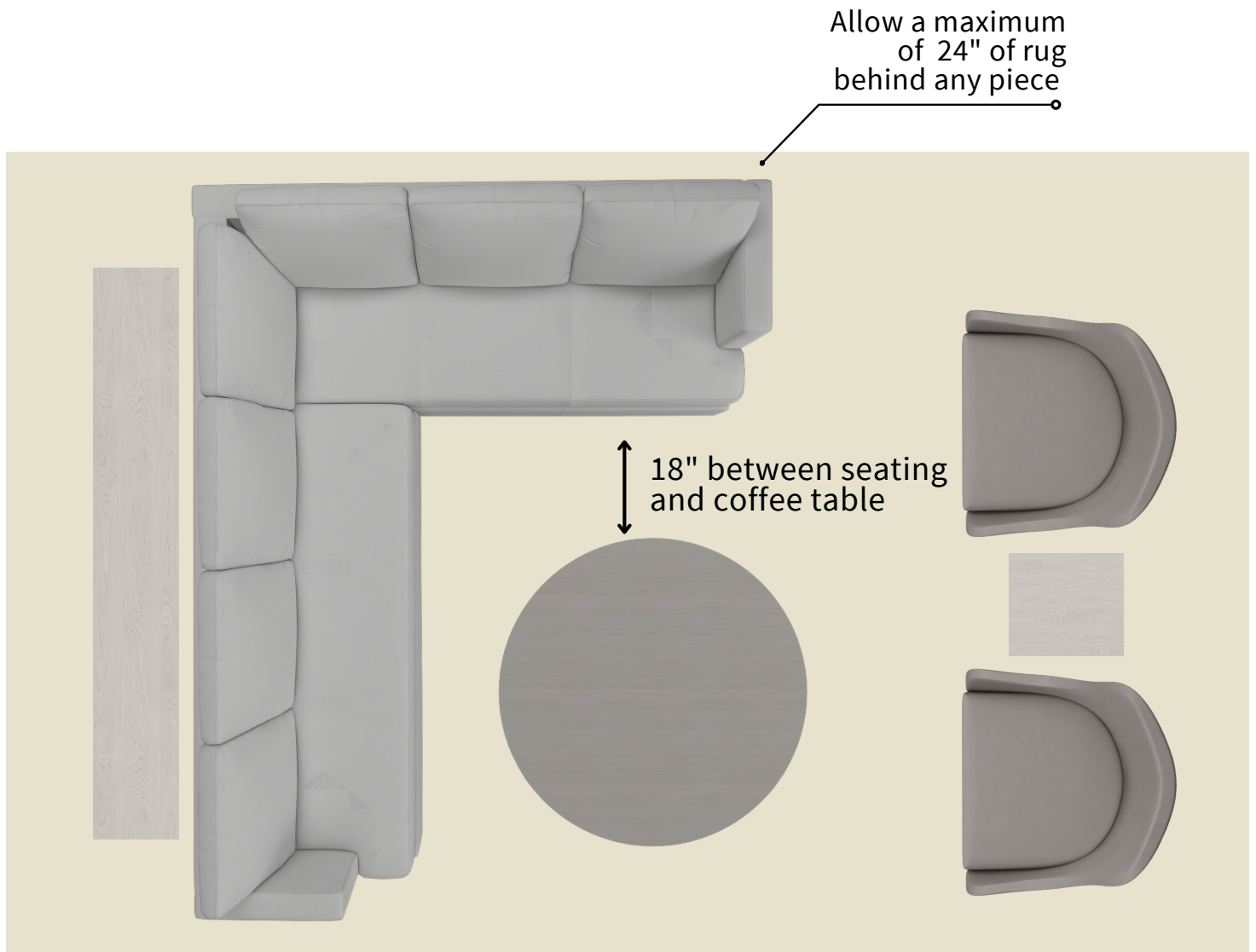

If you have enough space, place a console table behind your sofa and use for extra lighting, decor, and storage.,

CRD

RUG SIZING: LARGE LIVING SPACE

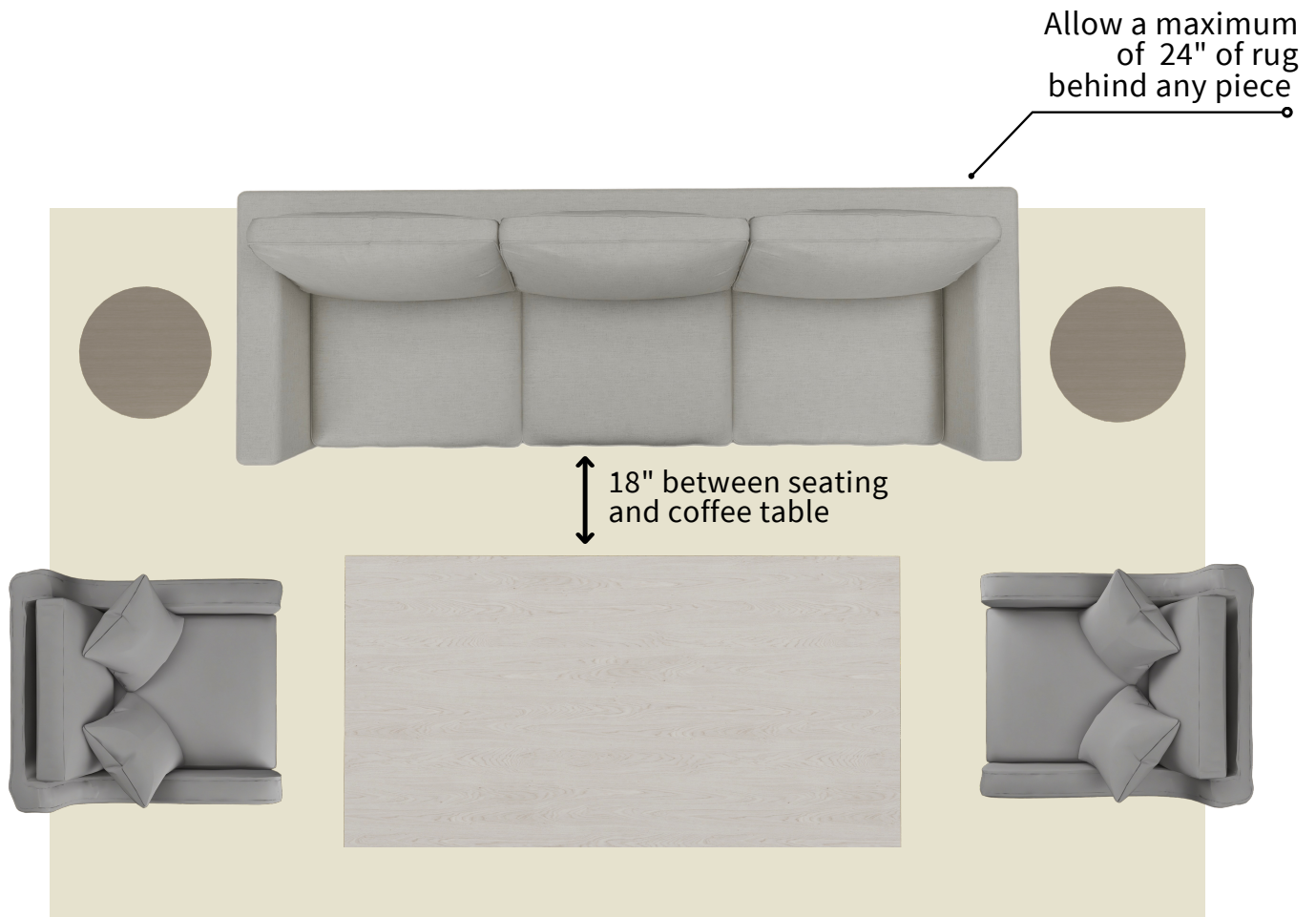

PRO-TIP

If your rug isn't large enough, you can just place the front furniture legs on the rug.

If the room is large enough, fit all furniture legs on the rug. Leave 36" of walking space around rug and 12" from any wall.

BEDROOM

KING/QUEEN

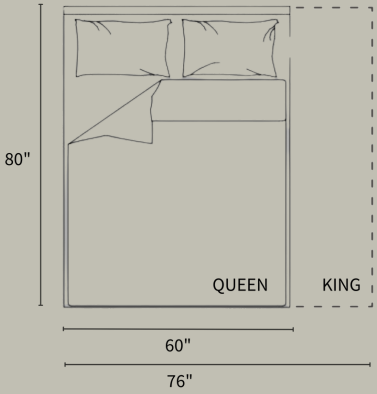

SUGGESTED SHAPES + SIZES

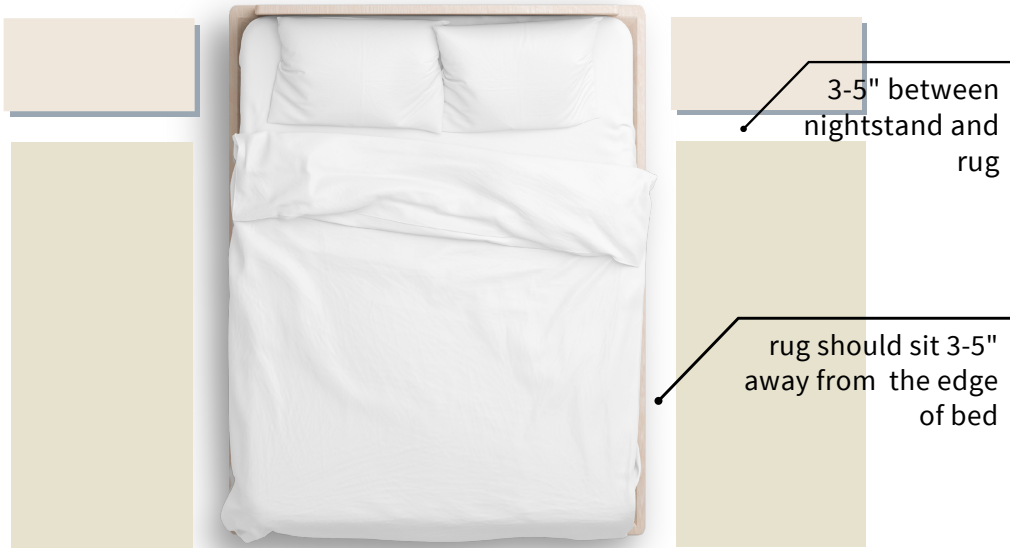
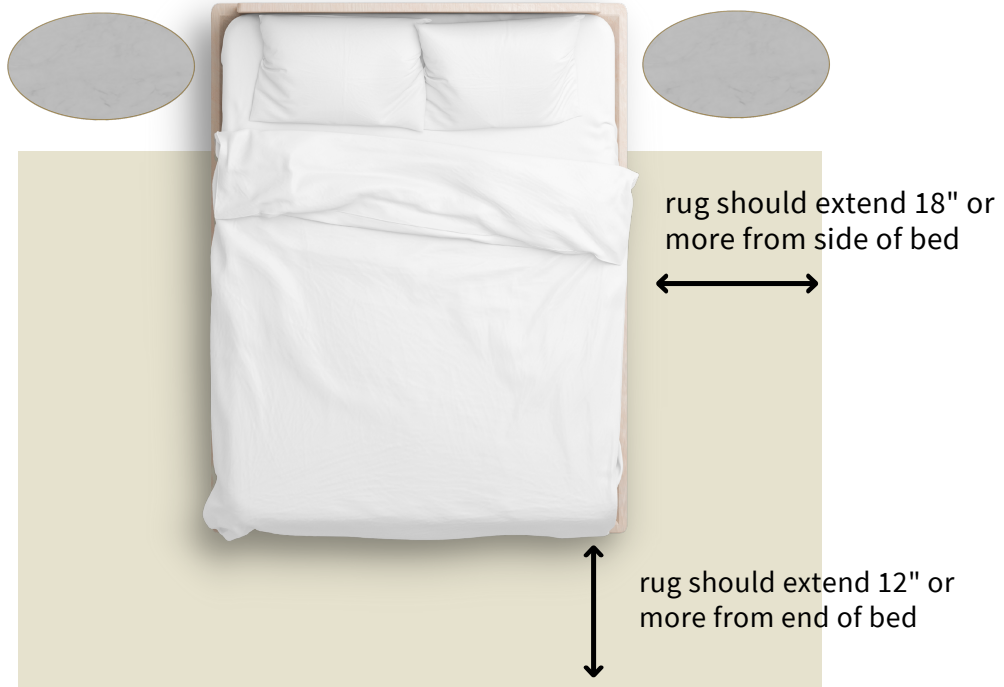
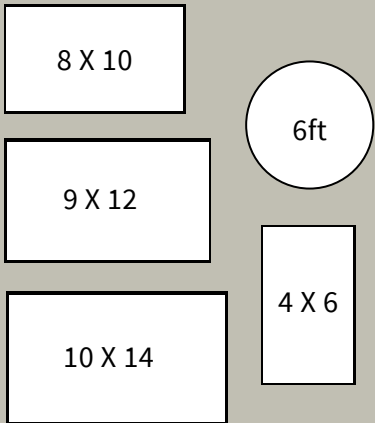

*Two runners can be a very cost effective option in place of a large rug

CRD

RUG SIZING GUIDE

BEDROOM

FULL/TWIN

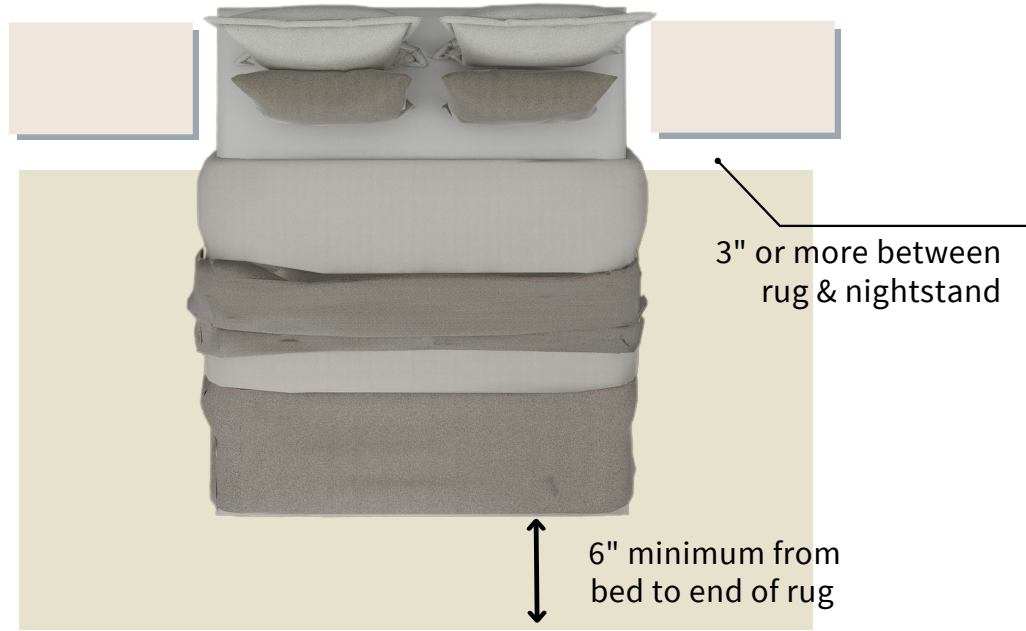
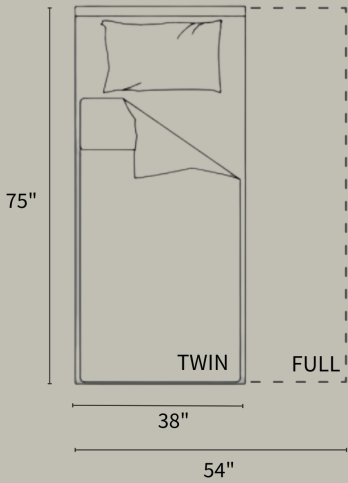

SUGGESTED SHAPES + SIZES

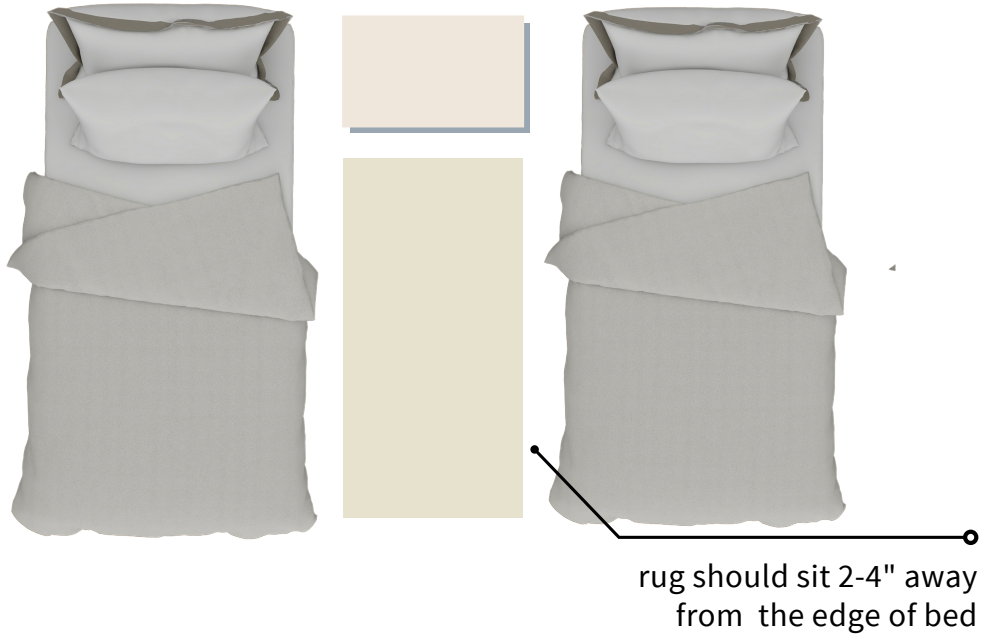
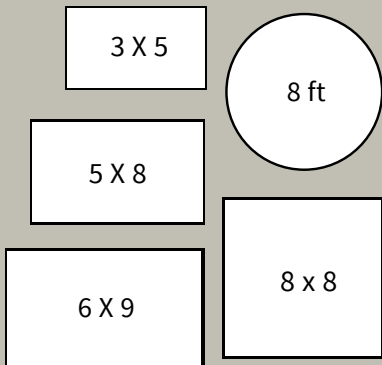

CRD

RUG SIZING GUIDE

CRD

TV HEIGHT
& DISTANCE
GUIDE

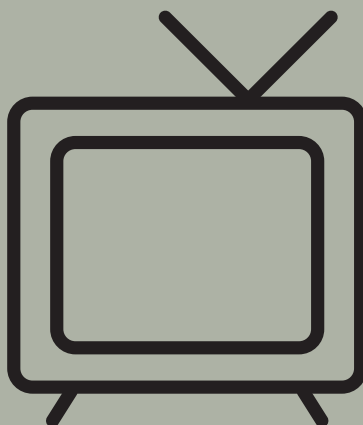

www.carolinerachdesigns.com

CRD

TV HEIGHT + DISTANCE

MEASUREMENT STANDARDS

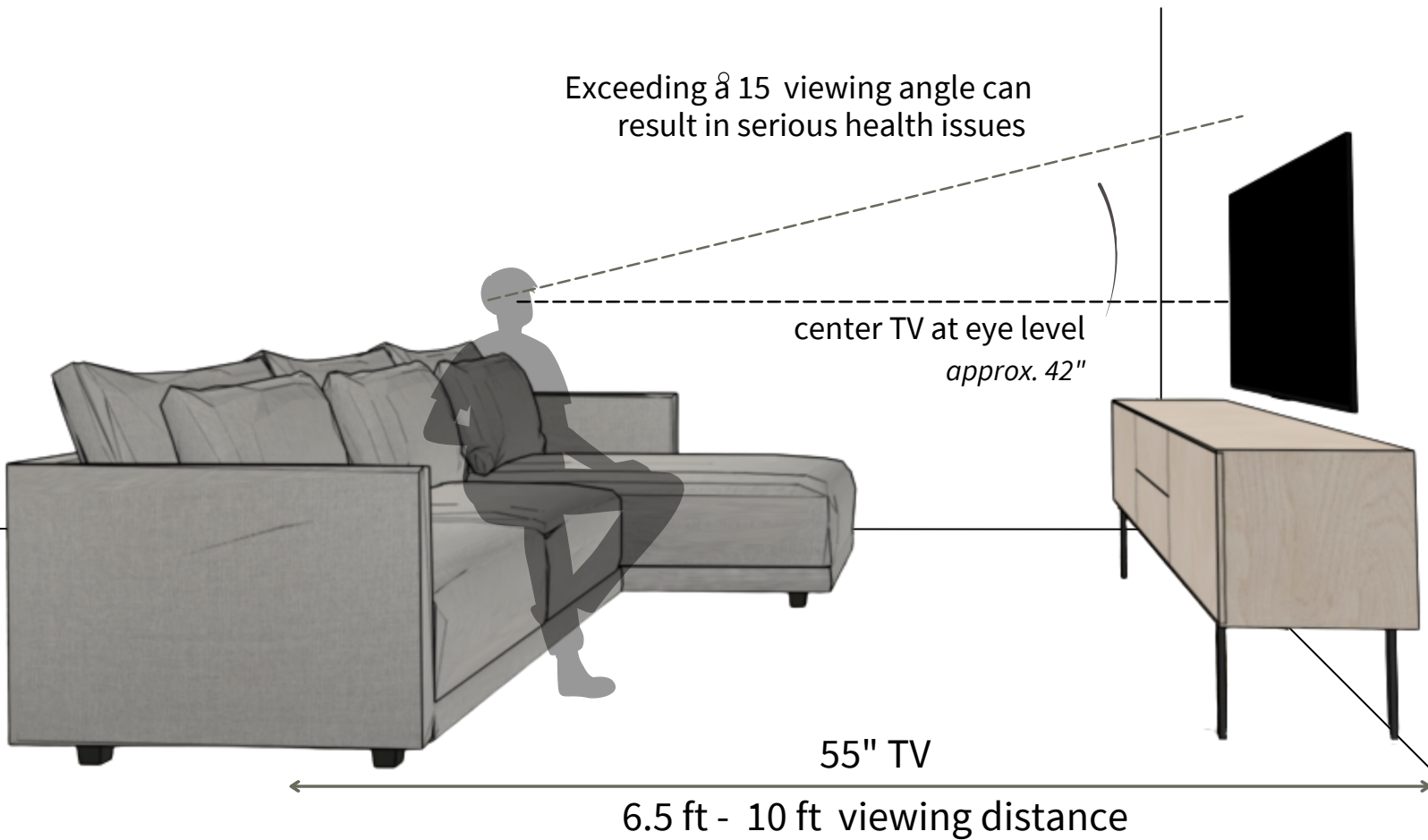

**These measurements are based on an average seat height of 16" and standard television heights*

CRD

TV HEIGHT + DISTANCE

MEASUREMENT STANDARDS

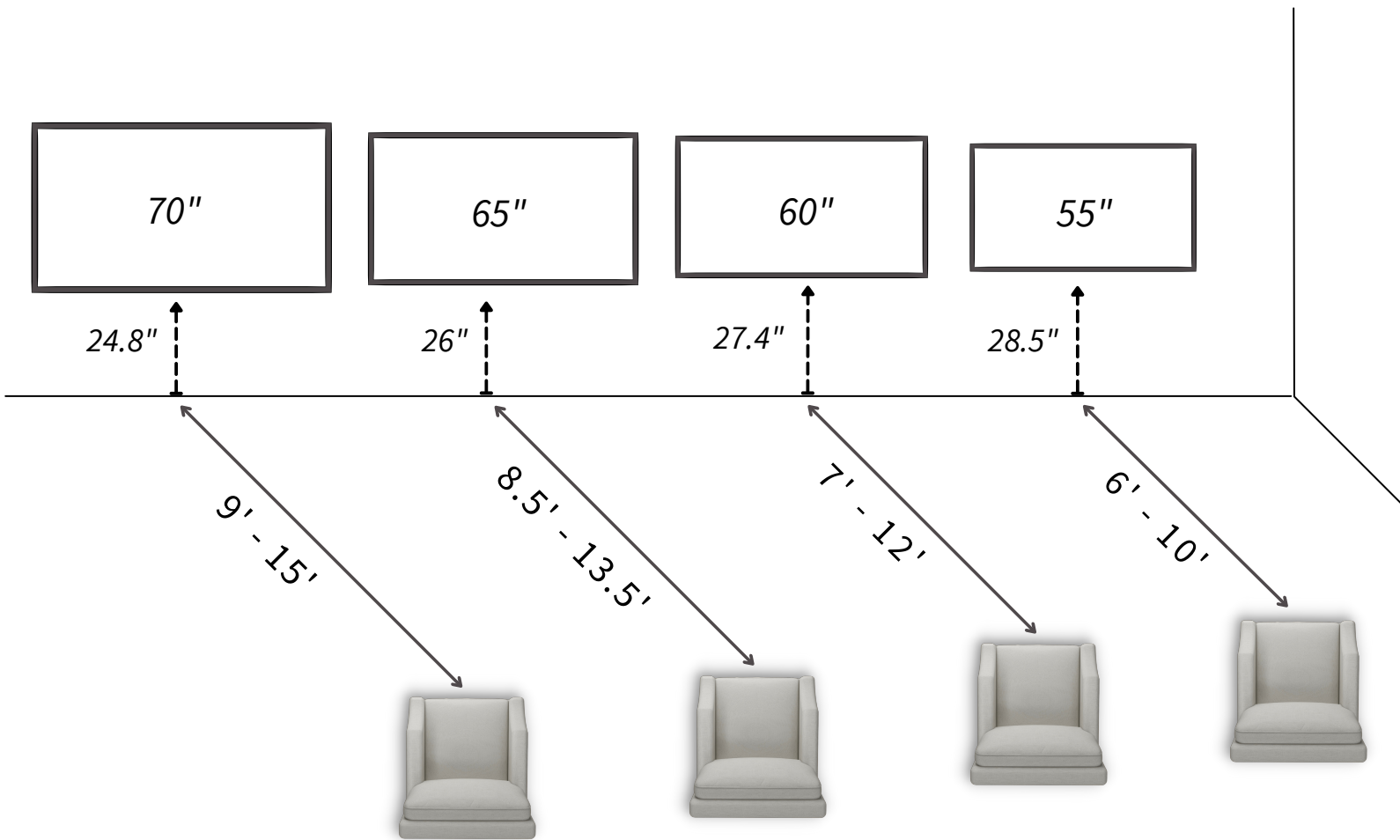

**These measurements are based on an average seat height of 16" and standard television heights*

CRD

LIGHTING INSTALLATION GUIDE

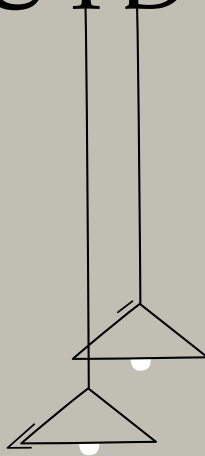

www.carolineriachdesigns.com

CRD

WALL MOUNTED LIGHTING INSTALLATION GUIDE

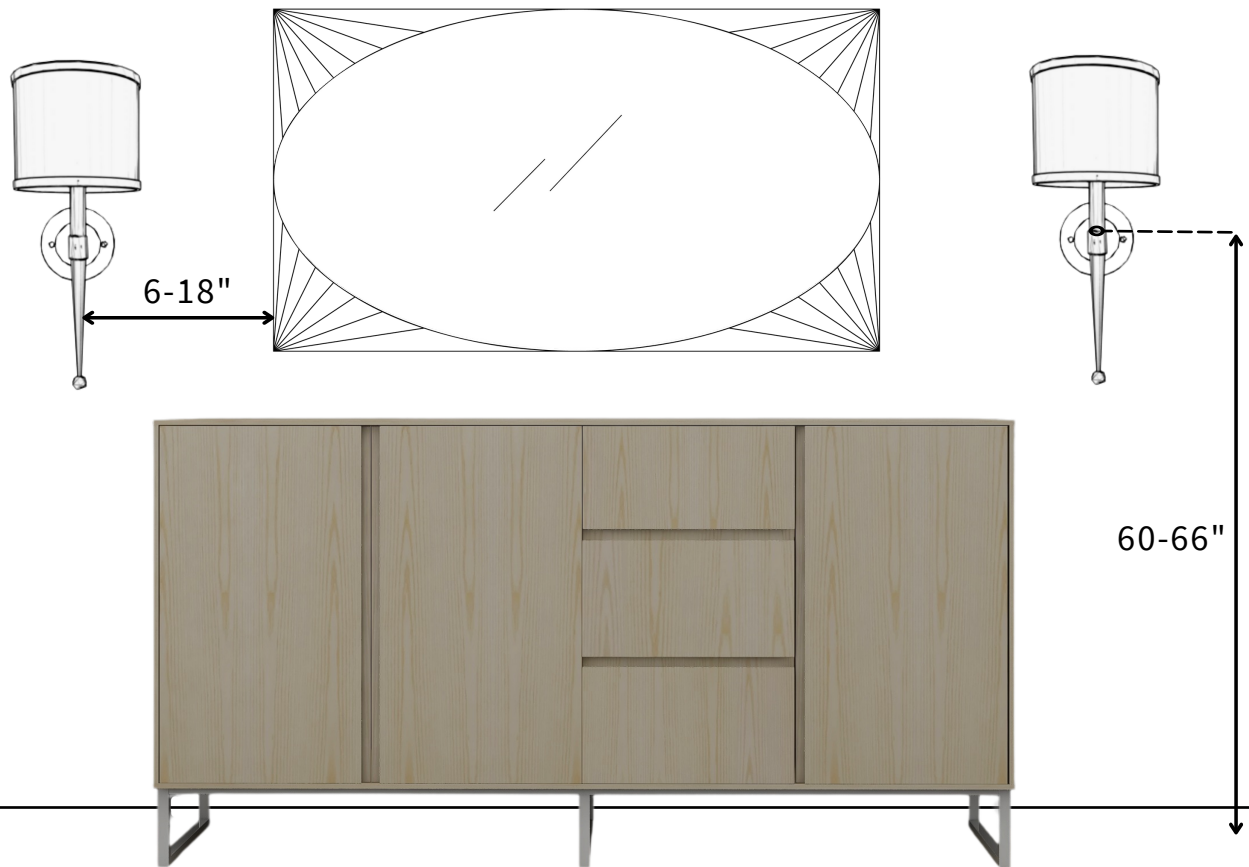

*Measuring for wall mounted lighting depends heavily on the user's height and wall dimensions

CRD

DINING ROOM LIGHTING INSTALLATION GUIDE

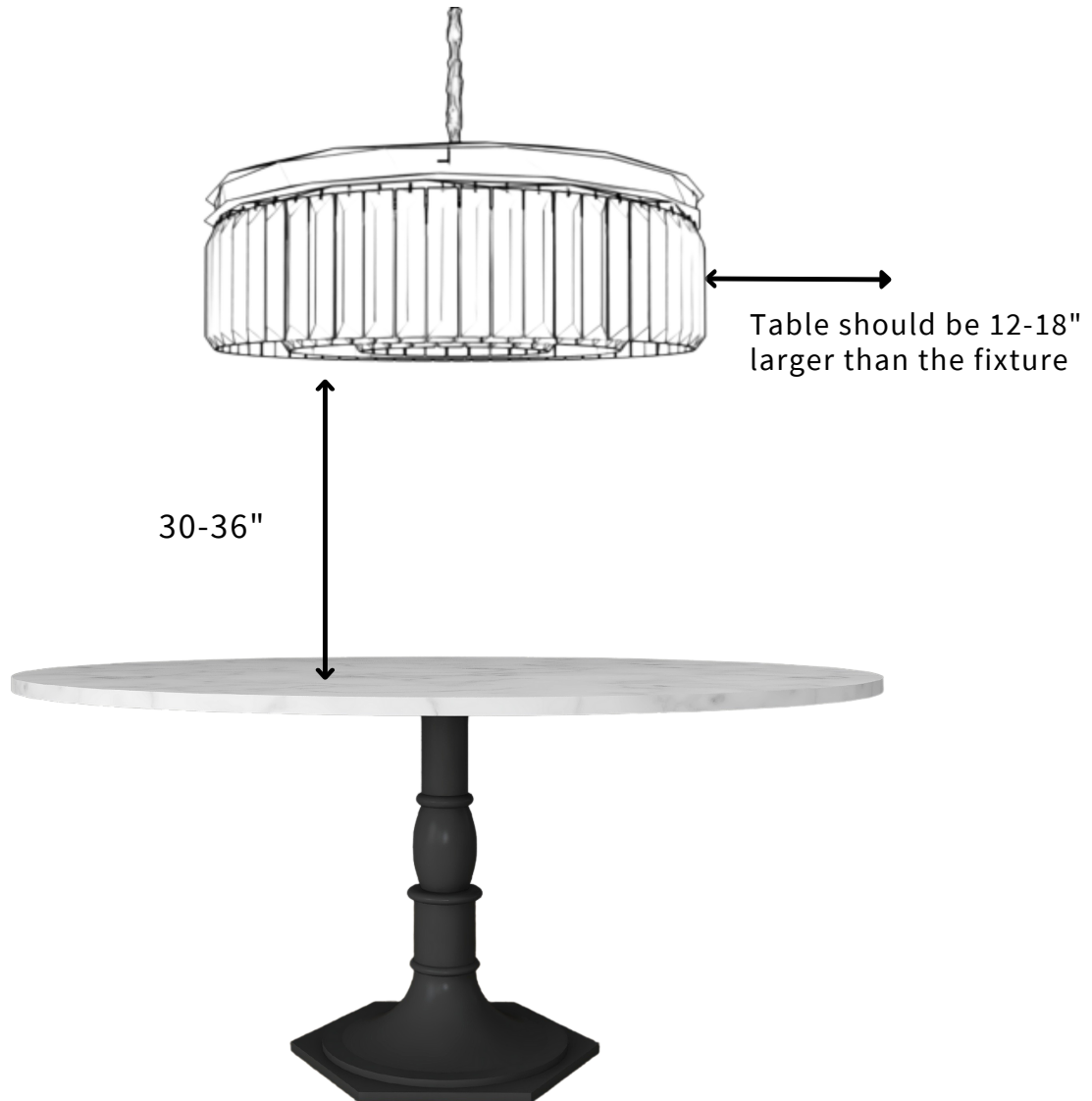

ROUND TABLES

CRD

DINING ROOM LIGHTING INSTALLATION GUIDE

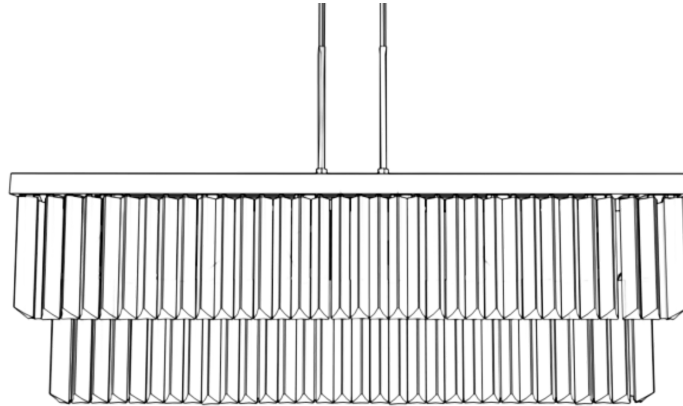
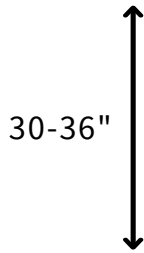

Table should be ~12" longer than the fixture on both ends and ~6" on sides



RECTANGLE TABLES

CRD

PENDANT LIGHTING INSTALLATION GUIDE

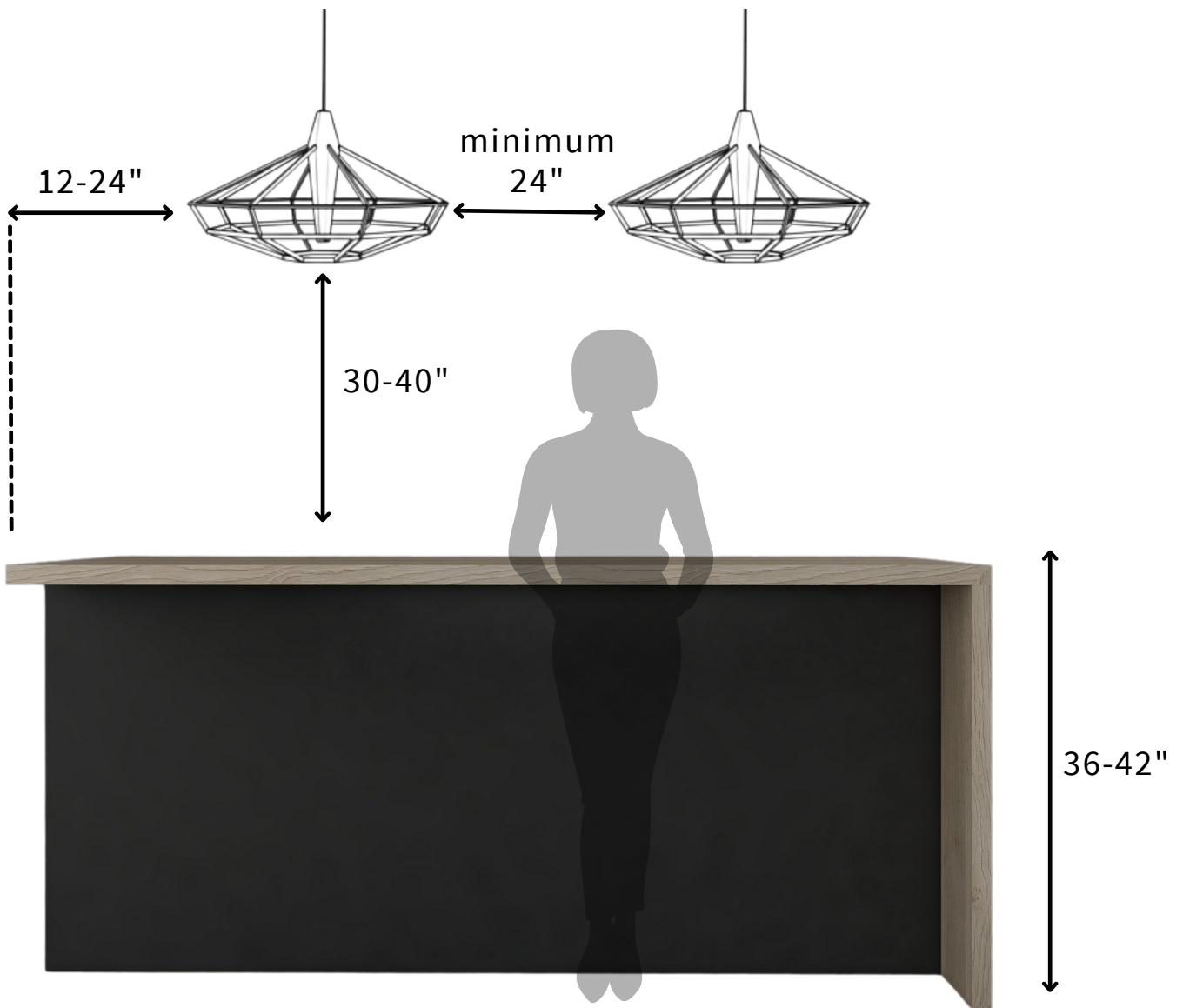

CRD

COUNTERTOP PENDANTS

INSTALLATION GUIDE

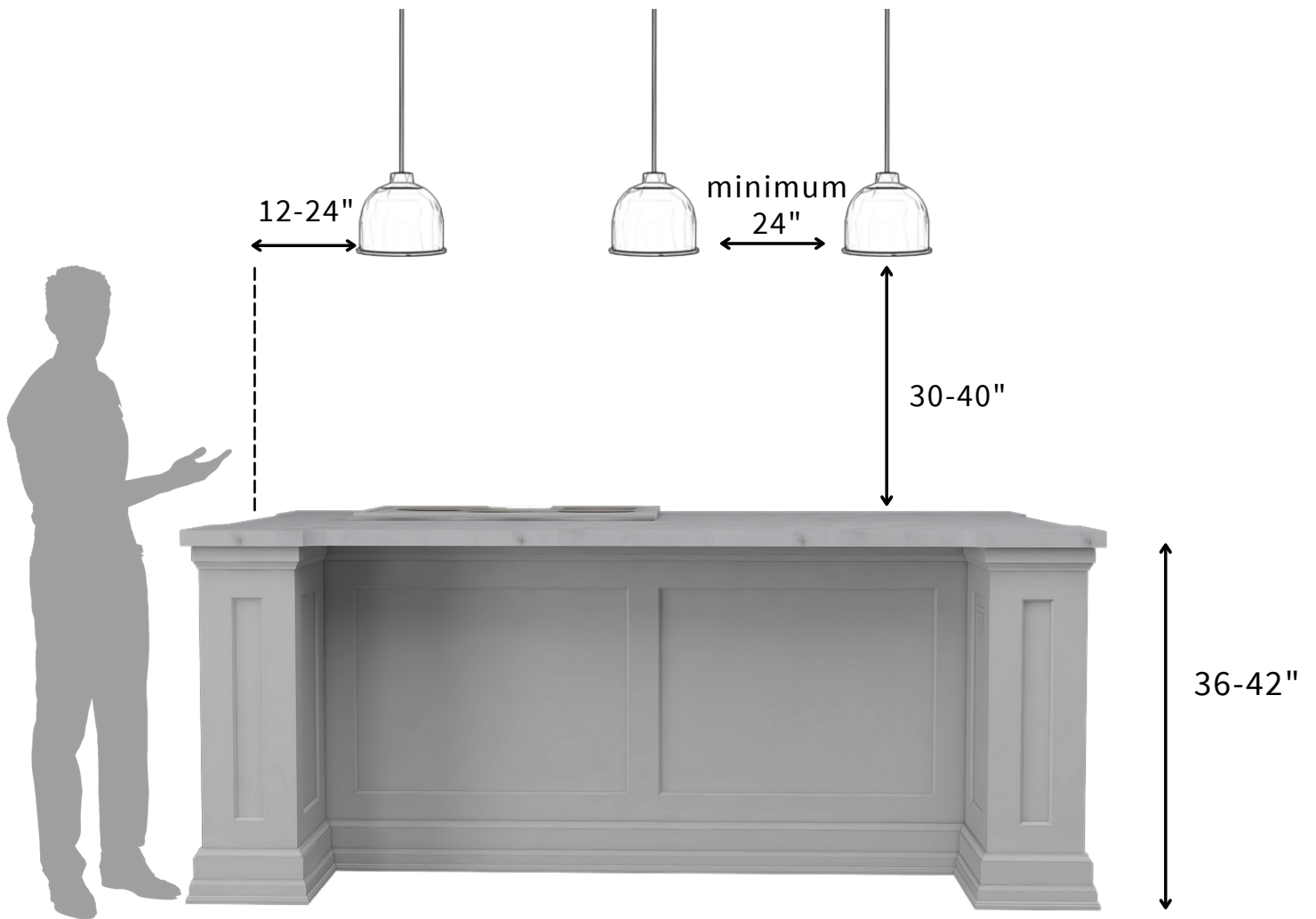

CRD

TABLE & FLOOR LAMPS

INSTALLATION GUIDE

How to pick the right one:

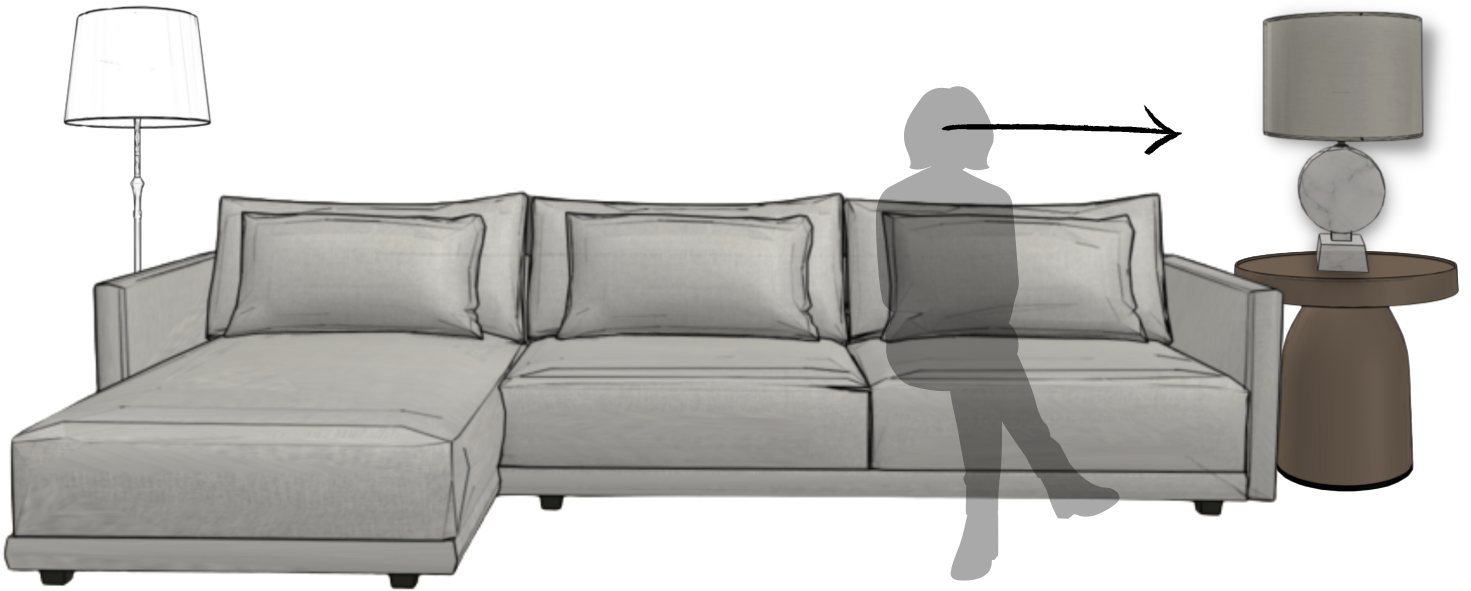

The bottom edge of the shade should be eye level for it to cast light in the right spot for reading, etc.

CRD

WALL HANGING INSTALLATION GUIDE

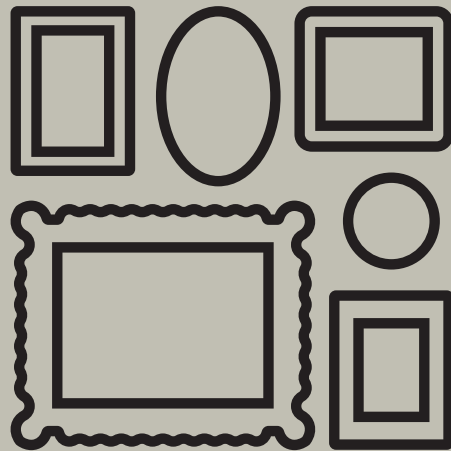

www.carolineroachdesigns.com

CRD

WALL HANGING INSTALLATION GUIDE

CONSOLE

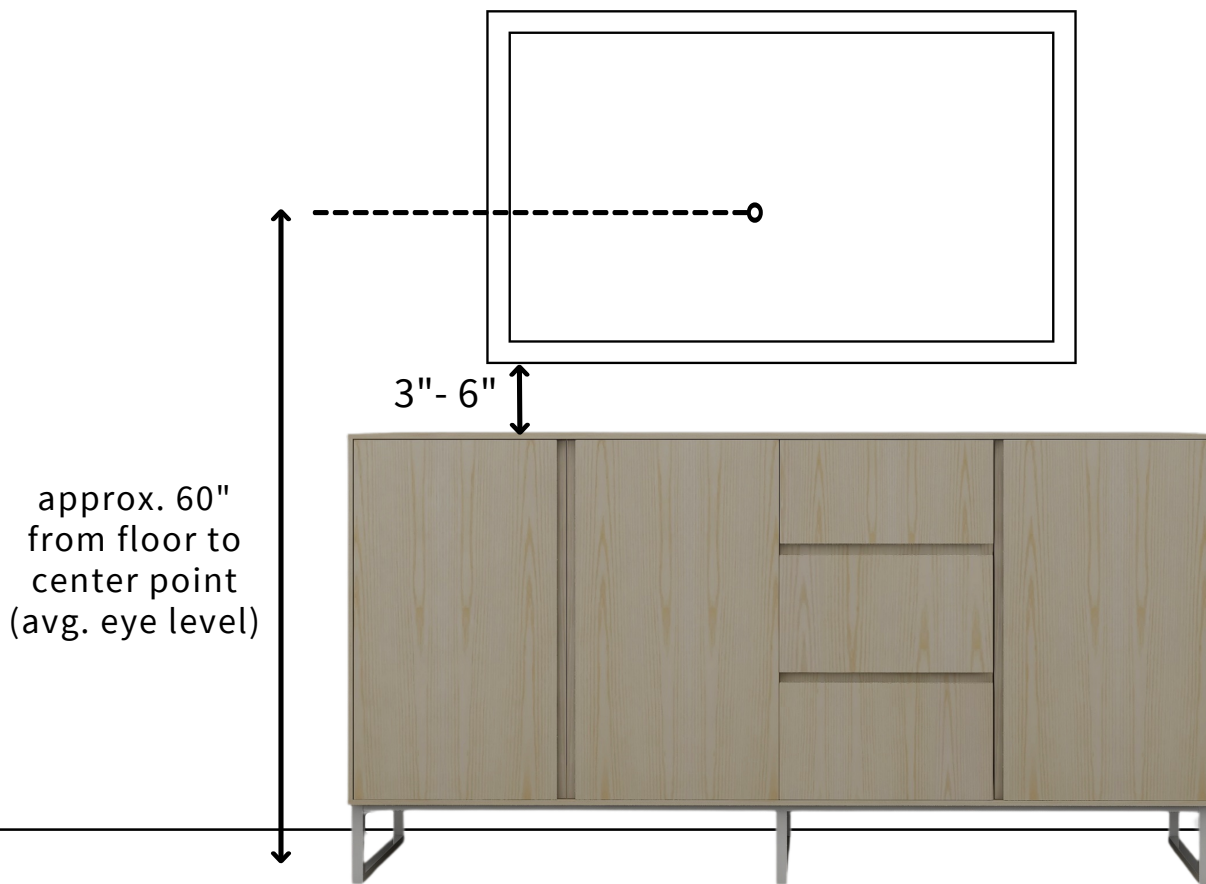

*The width of the art or mirror should be about $\frac{2}{3}$ of the piece its hanging above. For larger wall spaces, use multiple items to accomplish the right scale.



CRP

GALLERY WALL INSTALLATION GUIDE

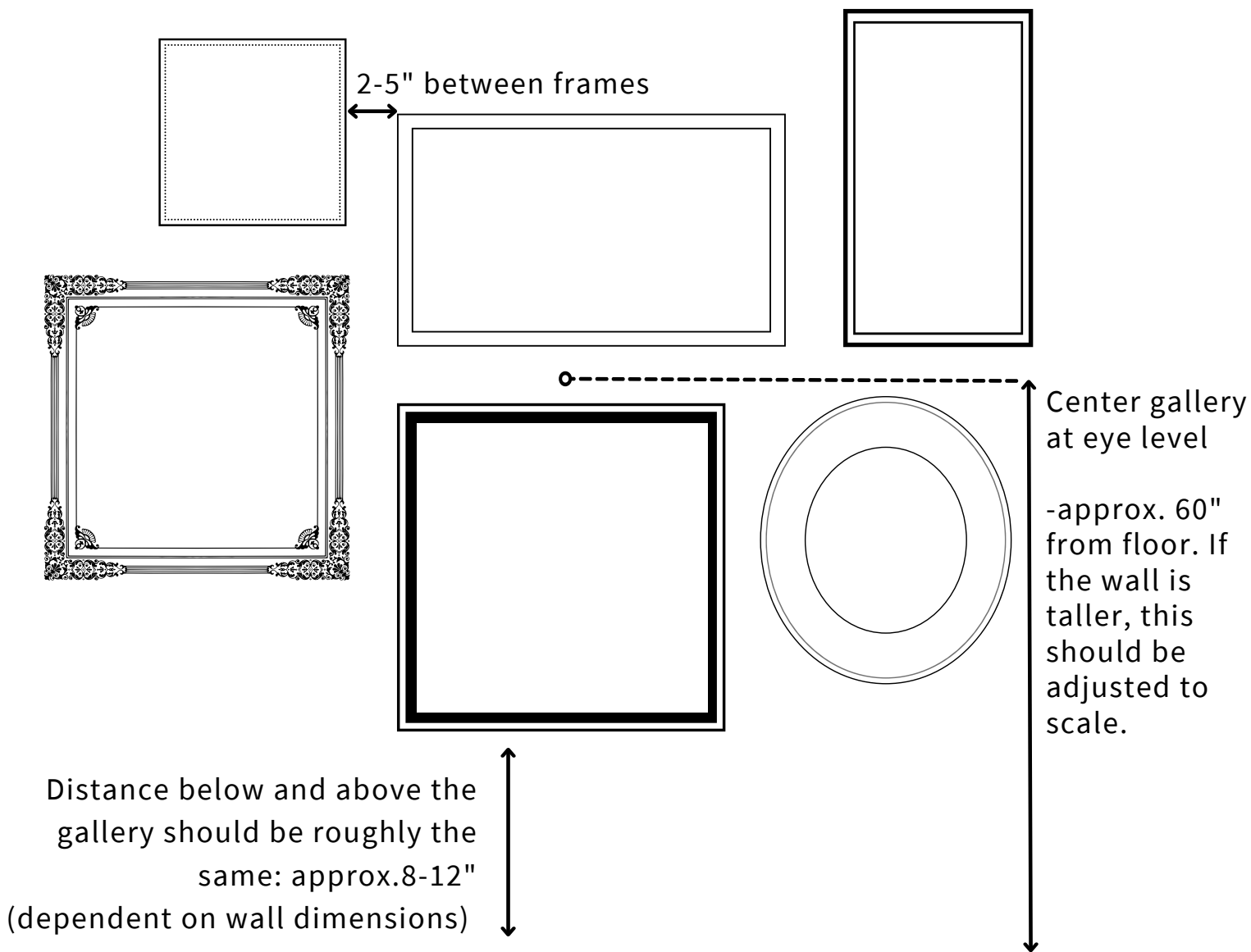

CRD

WALL HANGING INSTALLATION GUIDE

When using multiple pieces, make sure the overall width is at least 2/3 the width of the sofa or console

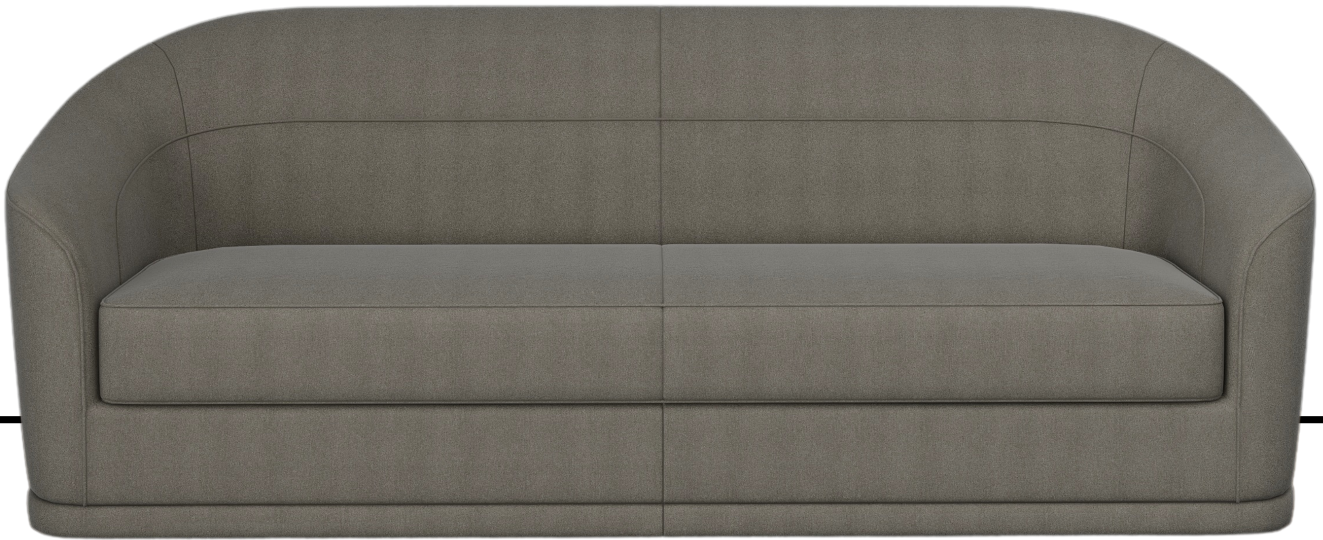
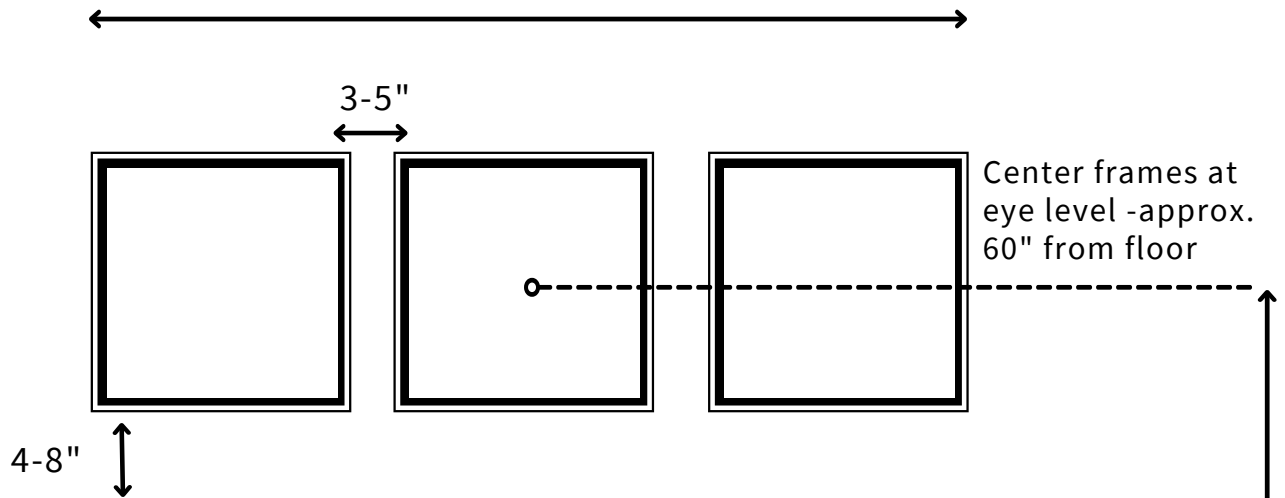

CRD

WALL HANGING INSTALLATION GUIDE

When using multiple pieces, make sure the overall width is at least 2/3 the width of the sofa or console

